

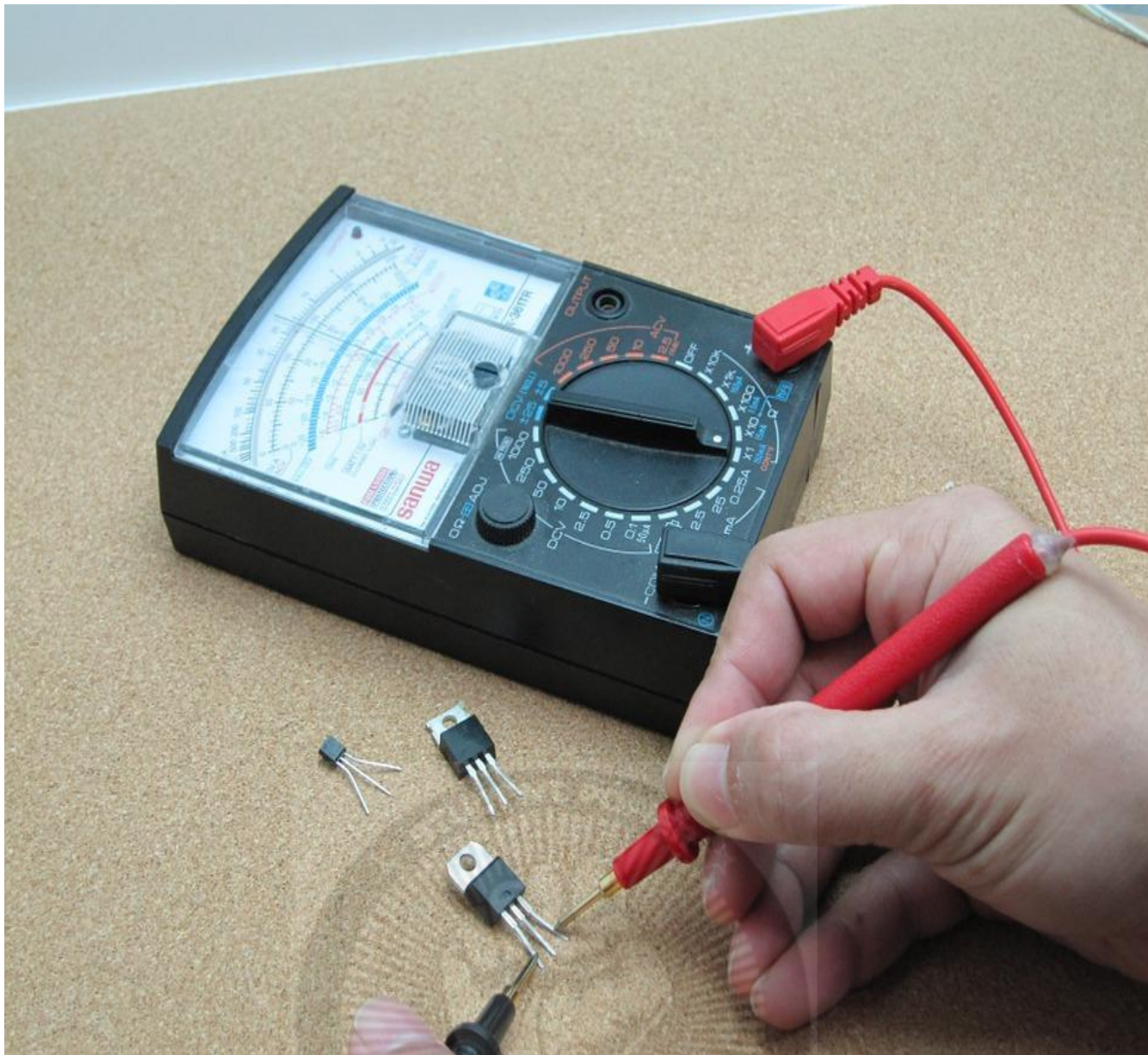

Basics of Electronic Components

Comprehensive book that helps you in learning and dealing professionally with electronic components and electronic device maintenance.



Ashraf Said AIMadhoun | Abdallah Abdl Rahman Al-Sdoudy.

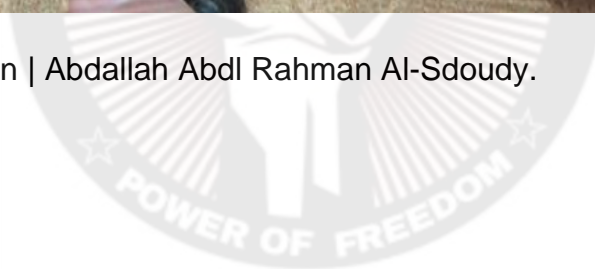



Dedication

This work is dedicated to

- ❖ To those who have seen the light, but haven't got any helping hand... **So**, they seek their way facing thorns of life with their soft hands...
- ❖ To those who confronted the dryness of life ... So planted a tree **in** every trail to resist the long summer day collapses ...
- ❖ To those who have lit candles to illuminate the way for those who would walk after them...





Table of contents

Contents

	2
Dedication	2
Table of contents	3
Preface	5
Passive components	7
Fuse	8
Resistor	9
Physical Units Prefixes	10
Potentiometer (Variable Resistor)	11
Capacitor	12
Variable Capacitor	14
Coils	15
Transformer	16
Crystal	17
Memristor	18
Electromechanical Components	19
Switches	19
Switches Types	20
Relays	22
Speaker	23
Motor	24
Different types and shapes of Motors	25
Active Components	26
Diodes	27
Rectifying Bridge	29
Schottky diode	30
Zener Diode	31
Varactor Diode, Tunnel Diode	32
BJT	33
FET	35
UJT	36
SCR	37



Diac _____	39
Triac _____	40
Optoelectronic devices _____	41
LED Light Emitting Diode _____	41
-Seven segment Displays _____	43
Simple LCD display _____	43
LDR Light Dependent Resistor _____	44
Photodiode _____	46
Solar Cell _____	47
Optocoupler Opto-isolator _____	51
IC Integrated circuits _____	53
Voltage Regulators _____	54
Operational Amplifier _____	55
Connecting Inverting and Non-Inverting Amplifier _____	56
Timer 555 _____	57
Conclusion _____	58





Preface

The electronics world is very large and certainly interesting. There are many levels and specialties related to the study of electronics science. Some of these levels focus on integrated circuits and digital systems, others focus on communication and programming and so on...

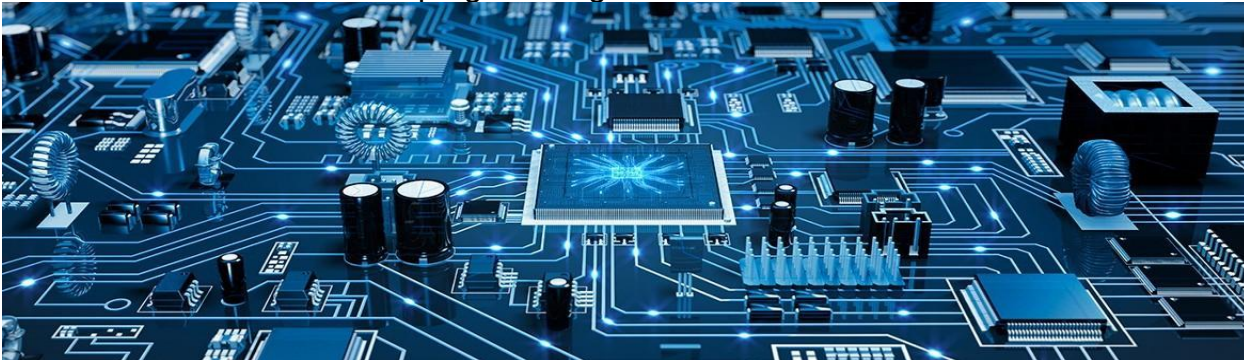

One of the most important and essential levels of electronics science is the full knowledge of electronic components.

What is it? What does it do? What is its symbol and units of measurement? How can they be tested and utilized?

In this book, we will identify the most important electronic components in general

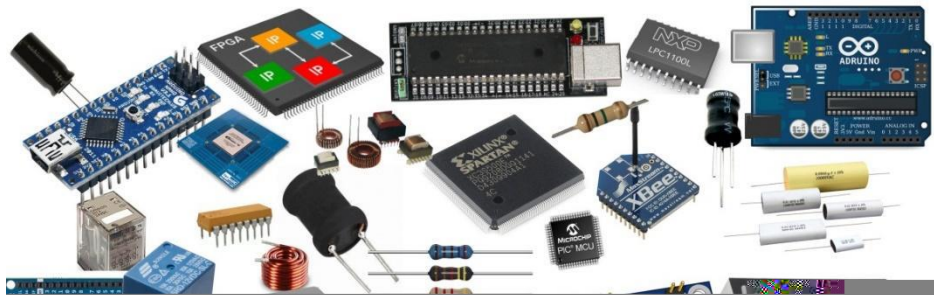

and review their functions, symbol, unit of measurement and examples of their use, I hope this scientific book to be beneficial for you.

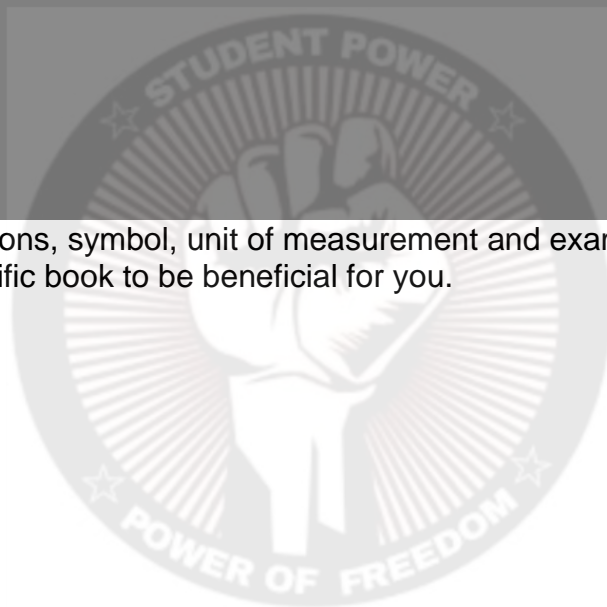



Before we begin.

There are many various electronic components and it is difficult to be covered in one book, so we will examine the most important, common and widely used components in electronics.

Electronic components are divided into groups:



Passive components	Very important and essential parts but they can't amplify the voltage
Electromechanical components	Contains moving parts
Active components	Used to amplify the voltage. They are also called semiconductors.
Optoelectronics components	Emits or receives light
IC integrated circuits	Electronic chips that contains complete circuits manufactured by high techniques.





Passive components

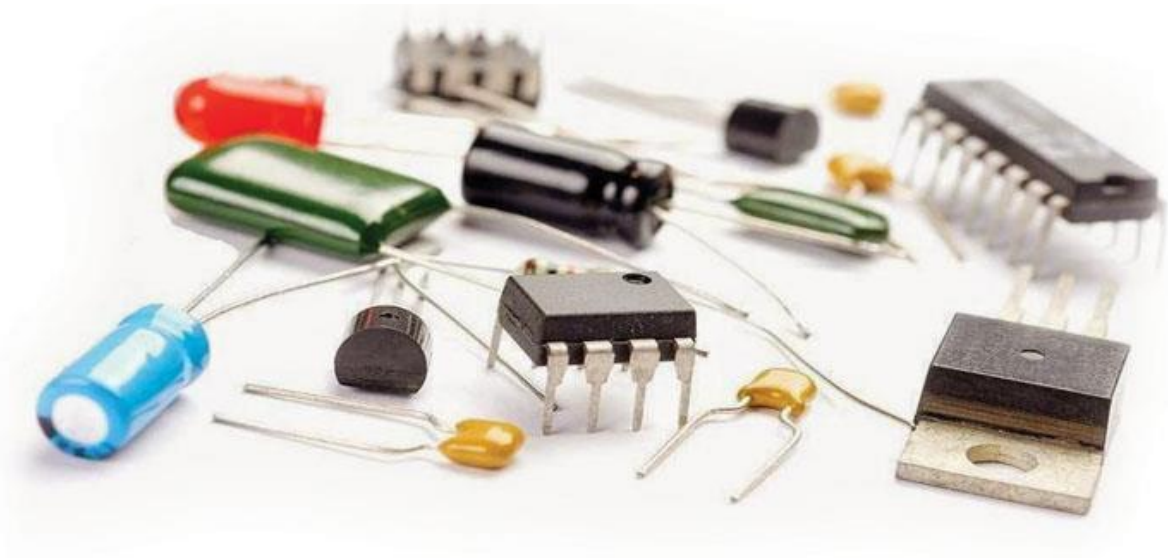

Passive components are easy to configure. Its operation depends on simple electrical and magnetic properties, these elements are essential in any electronic circuit but cannot amplify the voltage and control it, as active components that we're going to study later.

Most important passive components:

- Fuse, **Resistance** R, Condenser C, **Coil** L, etc....





Fuse

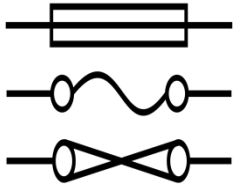

Function: The fuse protects electronic circuits and devices from overcurrent. It contains a sensitive wire that melts if the current exceeds the specified amount of the fuse.

- Unit of **measurement:** The fuse is measured in ampere A, the maximum current that a fuse can withstand before it breaks.

Features: Fuses are easily damaged. There are different shapes and sizes, and some are slow to cut.

Damage signs: internal burning, discoloration, wire cut.

Test Method: The multimeter is used to test the fuse, and the easy way is to set the multimeter to the ring out position or the resistance position by connecting the multimeter terminals to the fuse. The fuse is damaged, if the multimeter shows an OL sign.

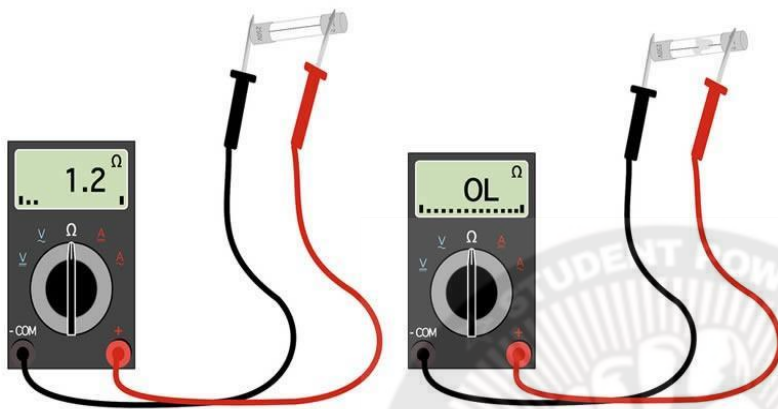

Good



Broken

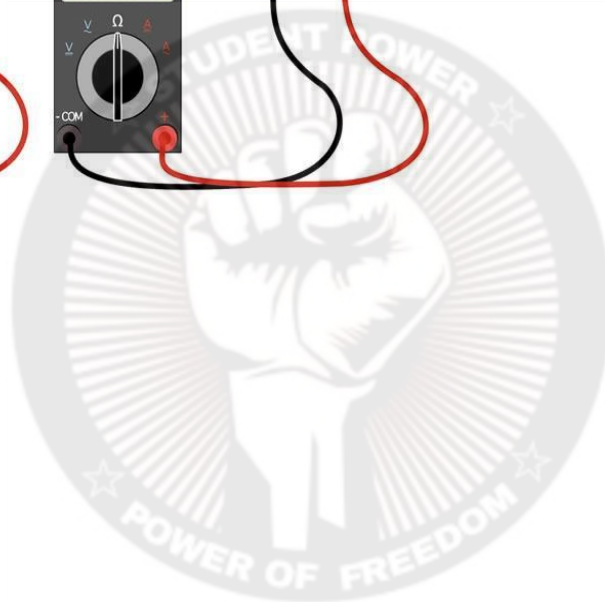



Resistor

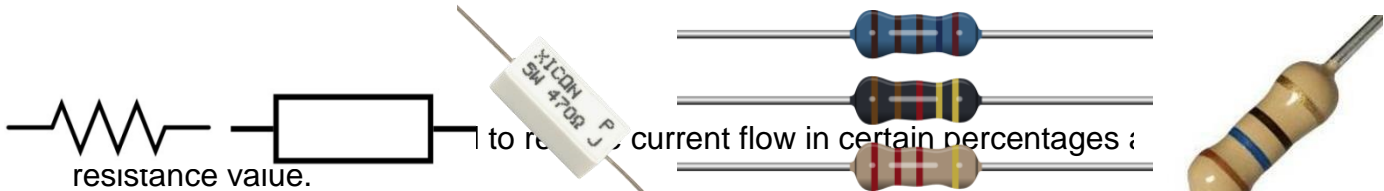

to reduce the current flow in certain percentages : resistance value.

- Unit of measurement: Resistance is measured by ohm Ω .

Features: Resistors vary depending on the value of the resistance (Ohms) and power (watts), size and percentage error

Damage signs: Burning, Breaking, Color change.



Test Method: The multimeter is used to read the resistance value. Connect the multimeter to the ohm position and connect the multimeter's terminals with the resistor's ones. Read the displayed value.

Color code in resistors: Resistance manufacturers use the color method to determine the value of resistance.

The following table shows how to read the resistors and the value of each color.

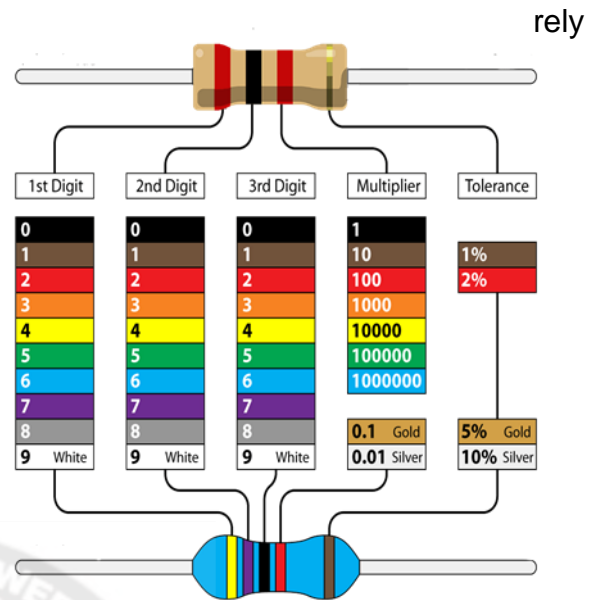



Physical Units Prefixes

We often deal with very large or very small numbers in physics and electricity, so multiples of these units are frequently used to facilitate their reading and pronunciation.

Exercise 1: Calculate the value of the following two resistances:

$$R1 = 4.7 \text{ K}\Omega + R2 = 120\Omega$$

Solution: symbol the Ω unit of resistance is Ohms while the $\text{k}\Omega$ equals 1000Ω

We must put 1000Ω instead of Kilo Ohm to perform the calculation

$$RT = 4.7 * 10^3 + 120 = 4820 \text{ k } \Omega$$

Exercise 2: You have two capacitors

$$C1 = 220\text{PF} \text{ and } C2 = 3\mu\text{F}$$

It is known the unit of measurement for Capacitors is:

Farad **F**

Multiplications p , μ , and n

Calculate the total capacitance of both capacitors:

$$\text{Solution: } Ct = 220 * 10^{-12} + 3 * 10^{-6}$$

Using a scientific calculator, we get

$$Ct = 0.00000300022\text{F}$$

This answer is correct, but it is bad to present it in this way.

The best way to present it is using metric prefixes as shown:

$$Ct = 3.00022 * 10^{-6} \text{ F}$$

$$\text{Or } Ct = 3.00022\mu\text{F}$$

T	Tera	10^{12}
G	Giga	10^9
M	Mega	10^6
K	Kilo	10^3
m	milli	10^{-3}
μ	Micro	10^{-6}
n	nano	10^{-9}
p	pico	10^{-12}

$$220 * 10^{-12} + 3 * 10^{-6} =$$

0.00000300022

x!	()	%	AC
ln	7	8	9	÷
log	4	5	6	×
$\sqrt{\quad}$	1	2	3	-
x^y	0	.	=	+

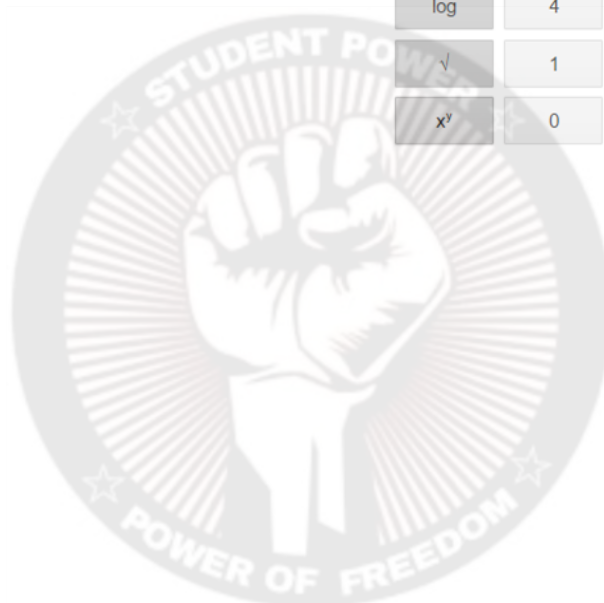

Potentiometer (Variable Resistor)

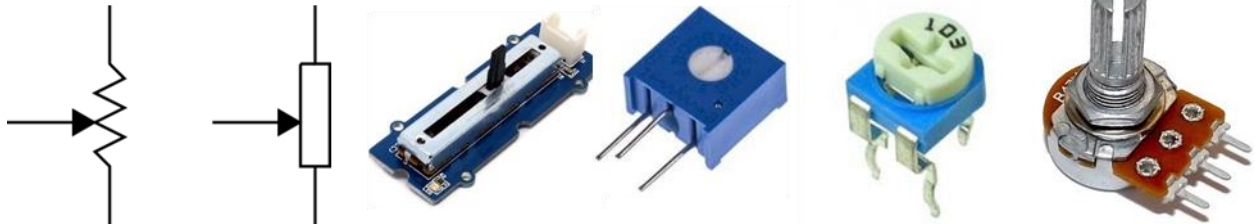

Function: reduce current's flow (as usual resistors), except we can change its value manually.

Unit of measurement: Ohm

Types:

- 1- Type that changes according to the rotational motion and it called potentiometer.
- 2- Type that changes according to linear motion and it called slider variable resistor.

Test Method: Put the multimeter on the resistance measurement. Put one end of the multimeter on the variable end (the middle one), and the other end of multimeter on any end of the resistor. Then, move the cursor from far right to far left. The resistance reading should change from zero to the maximum resistance value written on it.

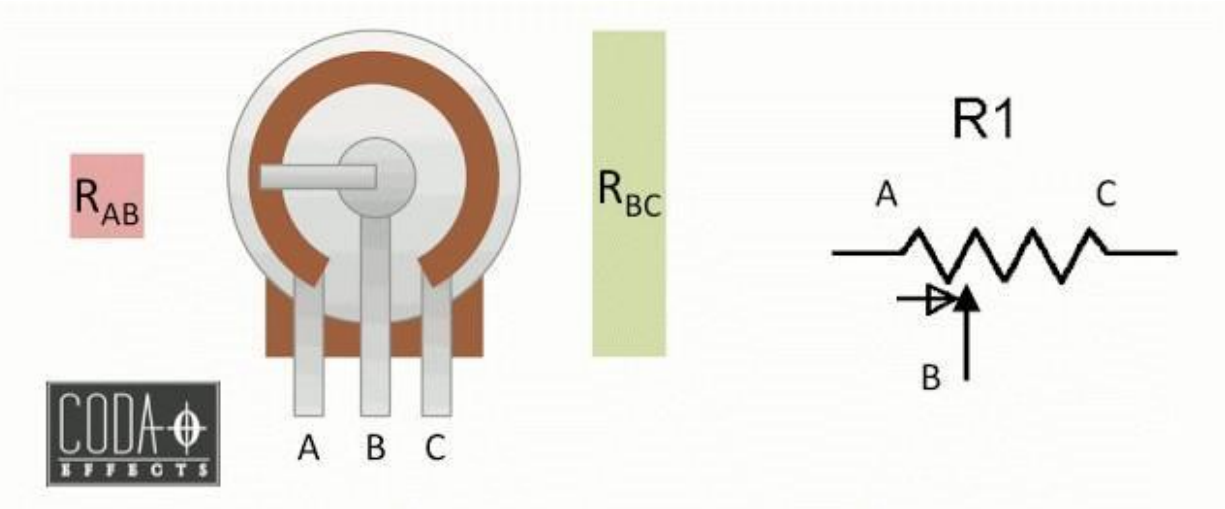

Capacitor

Function: storing a small charge, then discharge it if the voltage decreases between its two

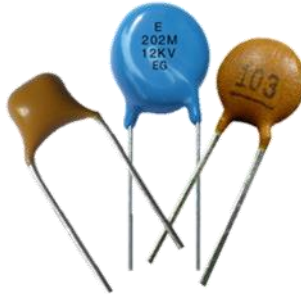
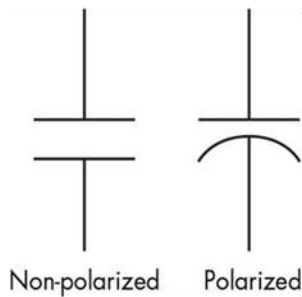

ends.

Unit measurement: Farad F

Species: There are two main types of capacitors

- 1- Electrolytic capacitor that has polarity (+/-).
- 2- Ceramic capacitor does not have polarity.

It is usually written on Chemical Capacitor All important information, such as capacitance, the maximum voltage endures, and maximum temperature, while the ceramic capacitor will be explained later.

Signs of damage: swelling from top or explosion, wax release, dehydration, strong odor.

Test method: Most modern multimeters have a capacitor measurement option and it is an easy way to test. We put the cursor on μF , put Multimeter's ends on the capacitor's ends and read the result. The proper capacitor will give a close reading of the one that written on it.

Note: Capacitors are sometimes highly charged. The charge should be discharged by resistance. As shown.

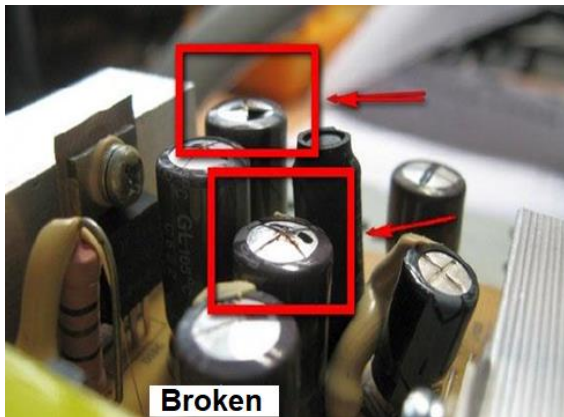

Damaged capacitors discharging



Capacitor measuring and

How to read a ceramic capacitor's value:

Normally, 3 numbers and a letter are written on the capacitor.

We can read the capacitance by:

Type the numbers that the first and second digits, the third one as (find the equivalent in the table) in the first block and multiply it with the second block. The results in Pico Farad. **The** character in the third column shows the error ratio.

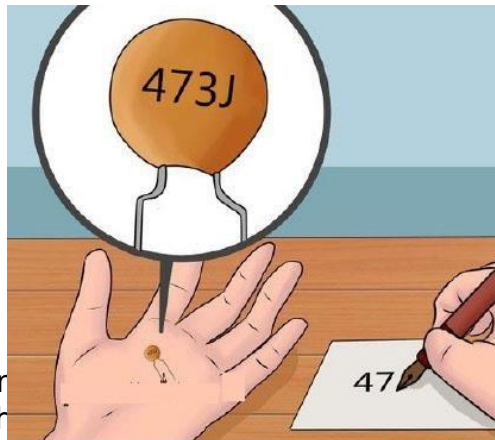

Example: Capacitor written 473J. How much is the error ratio in the capacitance in Farad, and how

Solution: $1000 * 47$

$$= 47000\text{pF}$$

Desirable to write value such 47nF

Error Ratio: 5%

Exercise: Capacitor with 309P written on it. How much it's capacity? What is the error ratio?

Solution: $3\text{pF} = 0.1 * 30$

Error Ratio: 0% -100% +

Variable Capacitor

Function: Variable capacitor works like a normal capacitor, but its capacitance can be changed manually.



Unit of measurement: Farad F

Characteristics: Variable capacitor is rarely used, usually used in telecommunication circuits.

Test Method: put the multimeter on the capacitance meter (capacitor test) and connect both ends of the multimeter to the center leg of the capacitor and any other end, and then measure the capacitance as the capacitor arm rotates. The capacitance of the capacitor should change from zero to the highest recorded value.



Coils

Function: The coils generate a magnetic field when an electric current pass through it.



Unit of measurement: Henry H.

Features: coils are rarely used in electronic circuits but frequently used in communications circuits, frequencies and transmitting and receiving operations. Each coil has its own number of twists and type of material the rings wrapped around it. There are coils with air heart, metallic heart, or paper heart.

Test Method: coils have very small resistance. The multimeter can, therefore, be used and the coil's resistance can be measured from both ends. Some of the coils are damaged by cutting and their resistance would be very high.

Some other coils have interrupts between their twists and this type of damage is difficult to detect by multimeter, so we use other devices like [LCR meter](#) and Ring Tester.

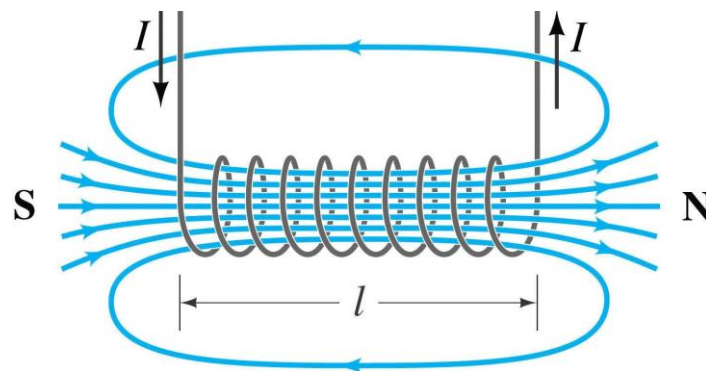

Transformer

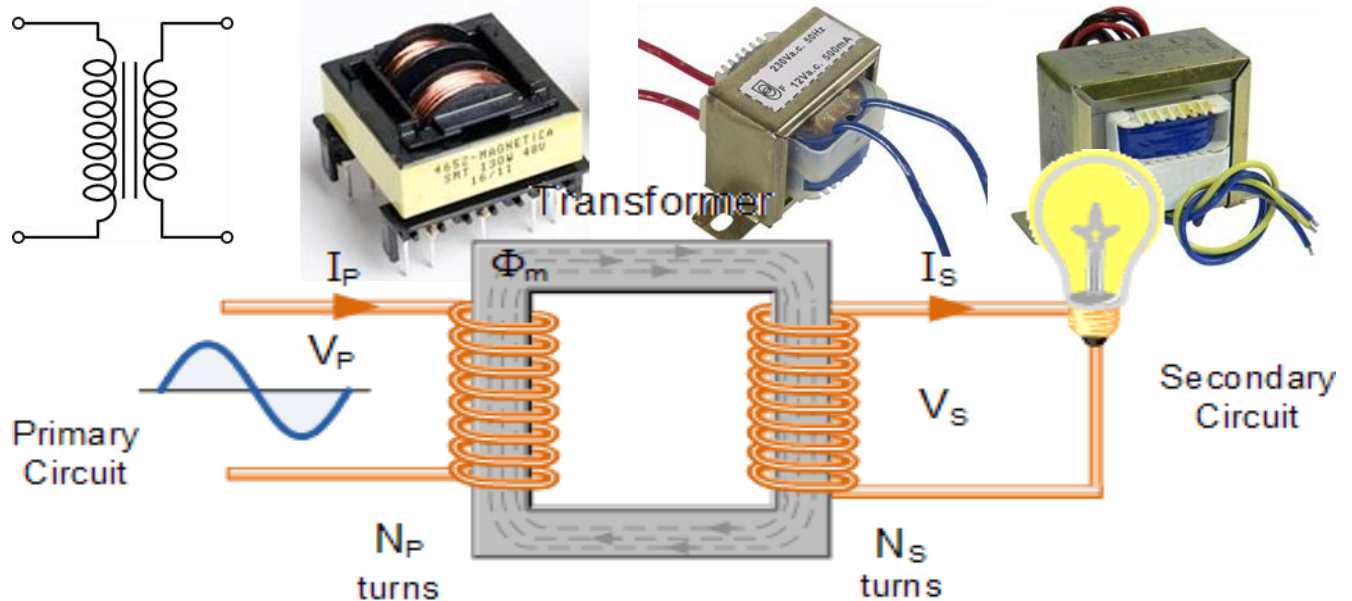

Function: The adapter raises or decreases the AC voltage. By converting electricity into a magnetic field in the primary winding, then converting the magnetic field into electrical energy in the secondary winding.

Unit of measurement: The transformer does not have a unit of measurement. But its function can be determined by knowing the appropriate input voltage and output voltage when operating the transformer in volts or by measuring the resistance of both primary and secondary coils.

Features: The transformer raises or decreases the voltage, except that it does not change the power (watt). The input power is equal to the output power, and the change is the inverse relationship between the current and the voltage (if you raise the voltage, the current decreases, and vice versa). Moreover, the transformers can contain more than two wires for the input inductor or the output one and that is used to control the voltage's values.

Test Method: The resistance of the two inductors (input inductor and output one) can first be measured using a multimeter. They both have a small resistance. Noticing that the value of the primary inductor is higher than the value of the secondary inductor. It is advisable to try the transformer by connecting a suitable input voltage to it and then measuring the output voltage on both ends of the secondary coil.

Crystal

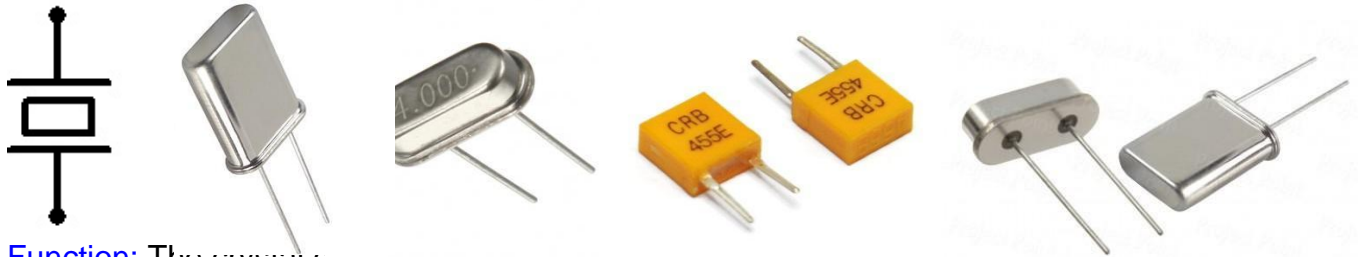

Function: The crystal generates a precise frequency.

Unit of measurement: The crystal is measured by the frequency it generates, and the frequency is measured in Hertz Hz.

Features: The crystal is usually poorly used, and it may be damaged when exposed to strong shocks. It is usually used in complicated circuits containing processors (e.g. Motherboard, TV, digital games and communication circuits)

Test method: Testing a Crystal is not simple. It is recommended to operate the device in which the crystal to be tested is placed.

Put the multimeter on the frequency measurement mode. Then, put the black wire on the ground of the circuit, and the red one on one of the crystal ends. Here, the measured frequency should be compared to the frequency written on the crystal.

Crystal's use: one of the most common uses is adjusting the frequency of the Atmega chip which is considered as the heart of the Arduino. A crystal must be connected to the Arduino as shown in the picture.

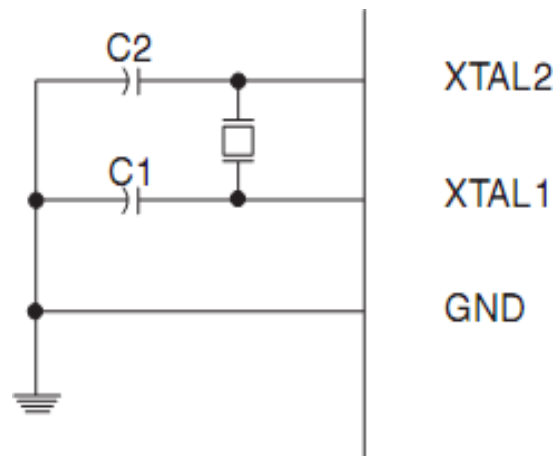
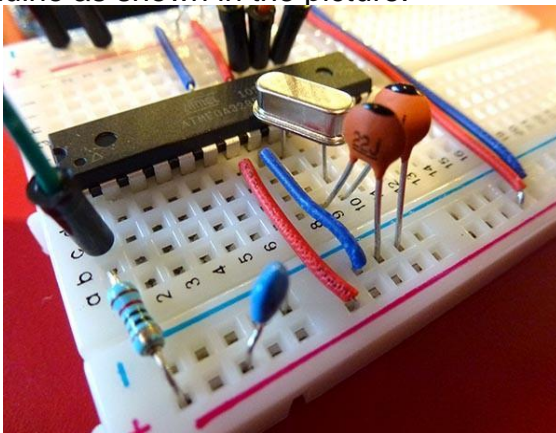

Memristor

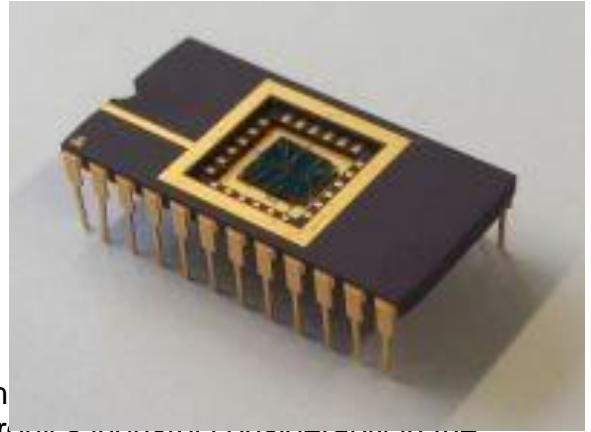
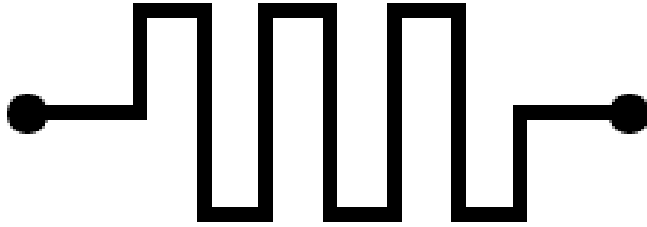

This element changes its resistance according to the history of the current that has flowed through it. This is a new technology that may change the electronics industry considerably in the future, except that this element is not used in the known devices we have so far. Unit of measurement: Ohm

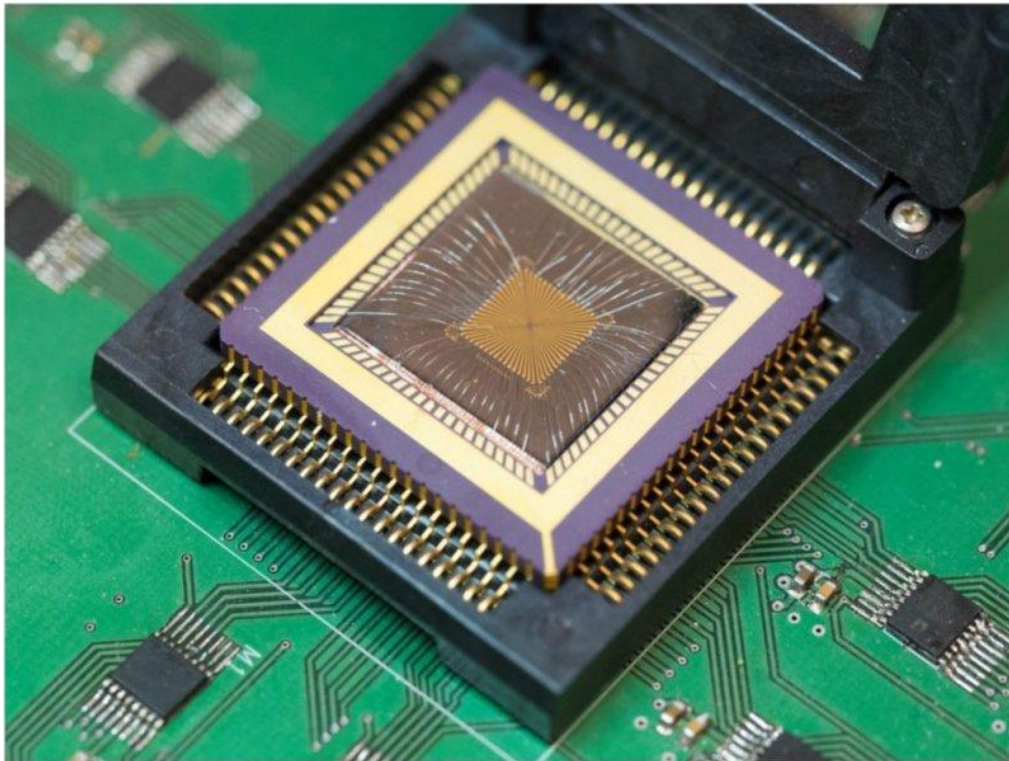

Electromechanical Components

Electromechanical components are elements that depend on motion and vibration in their work

It is called electromechanical because it combines mechanical, electrical and electronic components.

Switches



Function: connects or disconnects the voltage from a circuit or a specific path in the circuit.



Test method: it is easy if you know its internal connection. You will need a multimeter at the ring out mode (sound only)





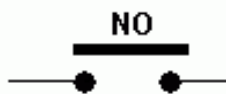

Place DMM Propes on the Coneectivity Test Mode
If the switch is ON you should hear a sound otherwise
it's broken

Switches Types

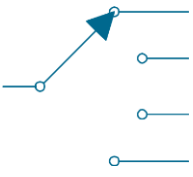
 <p>SPST</p>	<p>ON / OFF SPST Single pole Single throw</p>	<p>turn on and off switch</p>
 <p>NO</p>	<p>Push button / normal open</p>	<p>Compressor switch</p>
 <p>NC</p>	<p>Push to brake switch</p>	<p>Disconnect compressor switch</p>
 <p>SPDT</p>	<p>SPDT switch (single pole double throw)</p>	<p>Two-Way switch</p>

	<p>Selector switch SP4T</p>	<p>Multiple-direction Switch</p>
	<p>Electromechanical switch SPDT is an Ordinary key but it is designed to sense the movement of objects not the pressure of a human hand.</p>	<p>Electromechanical switch</p>

Relays

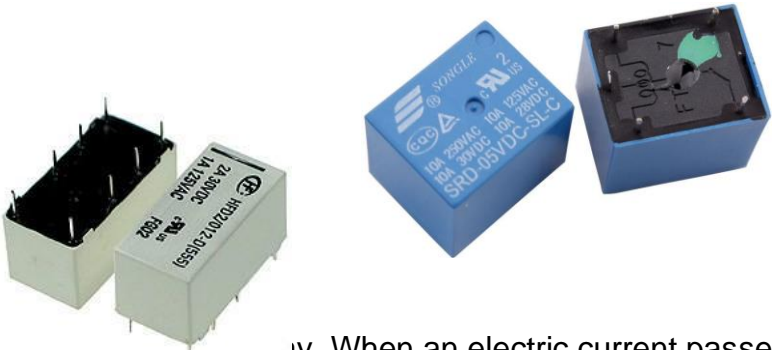
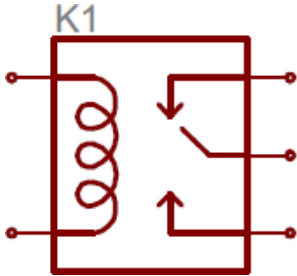

Function: Relay controls a switch. When an electric current passes through a coil, the adjacent switch changes its state from disconnection to connection or vice versa, making it very useful for control; With a small Voltage on the coil, a Very high voltage can be presented between the ends of the switch.

Unit of measurement: The voltage of the coil is measured in Volt while the maximum current passing through the switch is measured in Ampere.

Features: The relays vary in the number and quality of the switches inside. The common type of relays has 5 ends: two ends of the coil. One common end of the switch called C, a connected end with C (without applying voltage called NC), and disconnected end from C (without applying voltage called ON).

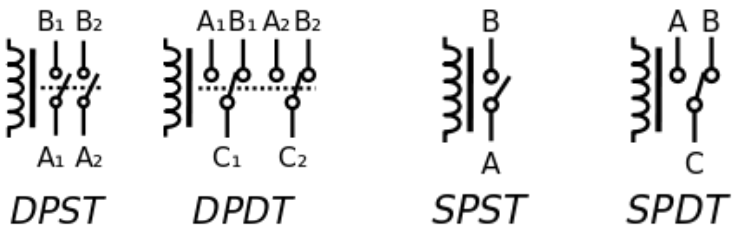
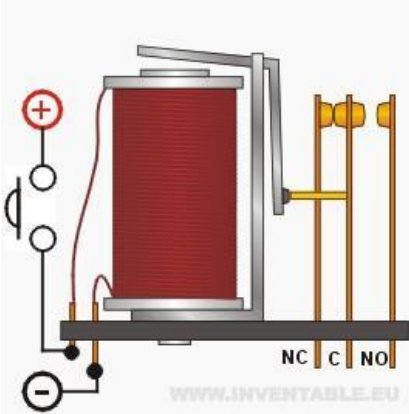

Disadvantages of the relay: relay is a large element, makes a noise when changing its status, and consumes a certain amount of energy, and generates a large magnetic field.

Test: Relay testing is an easy process. You will need a multimeter on the beep mode (sound is to test the connection), and an appropriate voltage source for the coil (battery or power source). Before connecting the voltage to the coil, the end c should be connected with NC. And after connecting the appropriate voltage to the coil, you will hear a sound and then you will find that the C terminal is connected with ON and also C is separated from NC.

Speaker

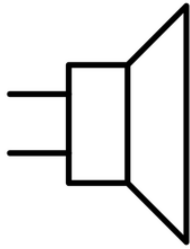

Function: The speaker converts electrical (AC) signals into sound. This is caused by vibrations due to the internal coil attracting and repelling the natural magnet.

Unit of measurement: speakers are measured in two units:

- 1- internal resistance measured in ohm.
- 2- power consumed measured in watt.

Features: The speakers vary according to their size, shape and sound quality.

Test Method: Use the multimeter to measure the internal coil resistance of the speaker first and compare it with the value written on it, or use the signal generator to generate a sine wave at a frequency such as 1000 Hz and listen to the sound.



Motor



Function: The motor converts electric power into a rotational motion.

Types: There are three main types of small electric motors used in electronics and robots:

The DC motor: it is the simplest type and the rotation direction can be changed by changing the polarity of the feeder, and it has only two ends.

Stepper motor: Its speed and angle of rotation can be accurately controlled, and usually it has five ends.

Servo motor: is a developed version on the DC motor. It has a sensor and gears and usually has three ends.

Test Method: Test the internal coils using a multimeter or connect the appropriate voltage and see the motor rotation.

Features: motor speed is measured by a number of cycles per minute rpm. Motor power can be increased using gears gearbox, but rotation speed will decrease a lot.

ATTENTION: motors usually consume high current and may damage electronic components that supply power. Therefore, it must be ensured that the elements that control the engine withstand current and high temperature.



Note heat dispersants in the active components that control motor speed in the next control circuit.

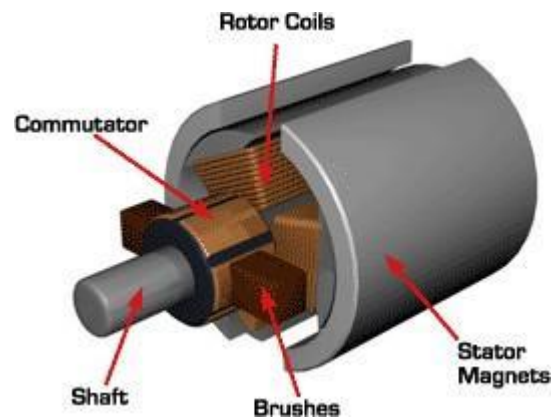

Different types and shapes of Motors



Active Components

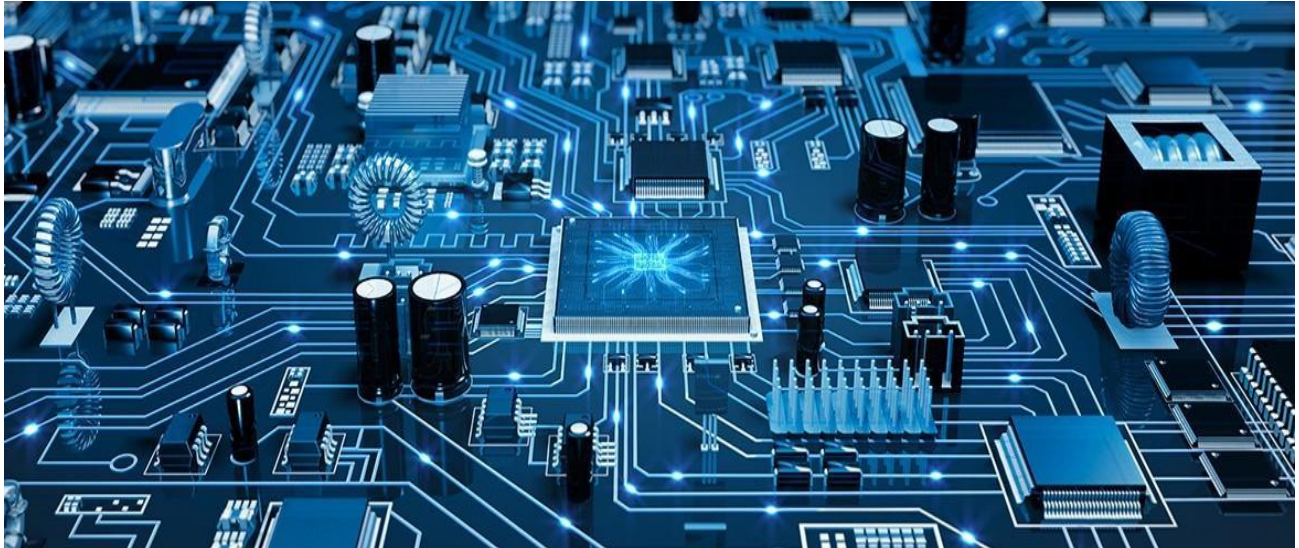

rubber. While there are materials that conduct electricity to a small degree called semiconductors, the most used materials for the manufacture of electronic components are silicon and germanium.

Silicon is found in nature and in sand in large quantities. Scientists have noted that silicon electrical resistance is high

So, they added other materials on silicon to control its resistance...

By adding materials such as phosphorus or Arsenic, the silicon resistance decreases, and it turns to a negatively charged material and called in electronics (**n**). If we add materials such as boron, the silicon resistance decreases, and it turns to a positively charged material and called in electronics (**p**). Electronic components are made of different combinations of these two materials types (**n and p**). Scientists could create lots of electronic components, which led to an industrial revolution in modern electronics and communications.



Diodes

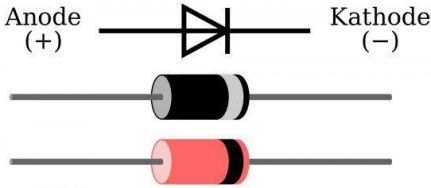
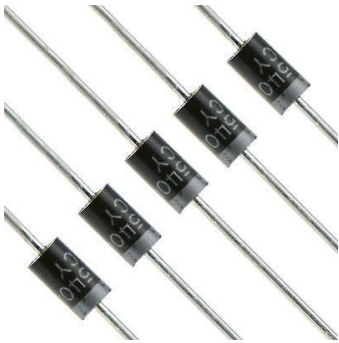

Function: Diodes allow the current to pass through one way if it is forward biased (the anode with the positive terminal and the cathode with the negative one), and it prevents it from passing when it is reverse biased. Diodes are used in voltage and converting it from AC to DC.

Features: diodes differ by its power, how much current it can handle and what will it do.

Test method: there is a diode testing option in the modern DMMs. We choose that option then connect the anode to the positive terminal, and the cathode to the negative terminal of the DMM. It will show you value. If you connect them vice versa it will show you a zero or OL (open loop).

A composite image illustrating diode testing. On the left, two digital multimeters (DMMs) are shown. The top one displays 'OL' and is labeled 'Good Diode' with 'Reverse Bias' indicated by a diode symbol and test probes. The bottom one displays '601' and is also labeled 'Good Diode' with 'Forward Bias' and 'Single Beep' indicated by a diode symbol, test probes, and a musical note icon. On the right, there are two diagrams: the top one shows a cross-section of a diode with 'p-type silicon' and 'n-type silicon' regions, and terminals for 'Anode' and 'Cathode'; the bottom one shows two physical diodes with their leads.

If we connect the anode with the positive side of the power and the cathode with the negative side, the similar charges will repel, which makes the resistance of the diode small and lets the current to pass through it. And that is called the forward bias. If we connect the cathode with the positive side of the power and the anode with the negative side, the similar charges will attract, which makes the resistance of the diode very high and doesn't allow the current to pass through it. And that is called the reverse bias.

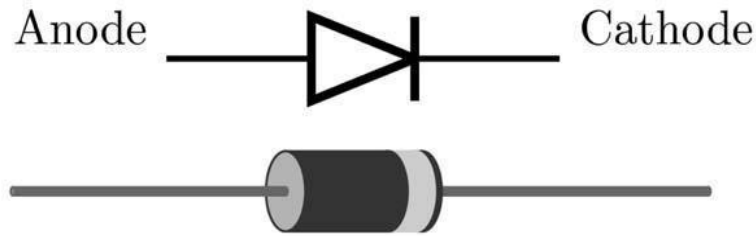

PakWheels.com

Characteristics curve:

We must understand the working of the active components using the curves. This helps the circuits' designers a lot when they design a new electric circuit. Curves explain the relation between the voltage and the current at the ends of the component.

The right side of the curve presents the forward bias region

Note: the diode did not allow the current to pass except when $V=0.7\text{V}$ olt.

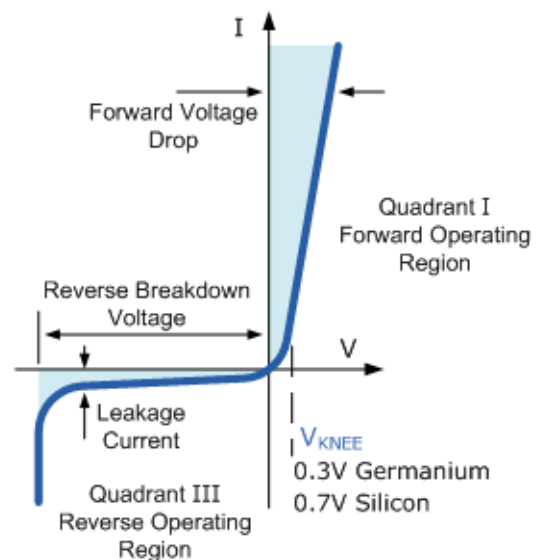

Rectifying Bridge

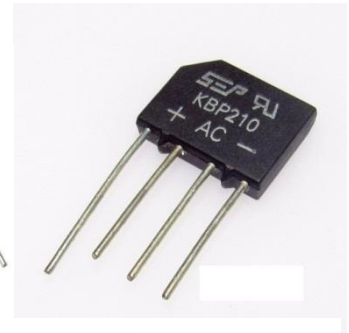
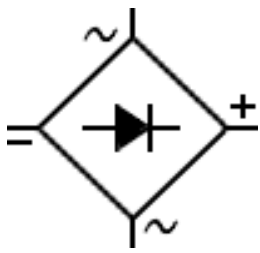

Function: the bridge converts the AC voltages to DC voltages. Rectifying Bridge consist of 4 diodes connected with each other in a specific way (as in the following figure). Each bridge has its own current that it can handle.

Test method: if you imagine the bridge as 4 diodes, it will be easy to test. Follow the terminals and test them by the diodes test method.

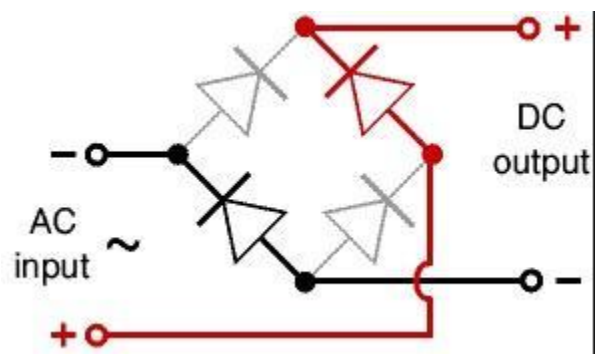
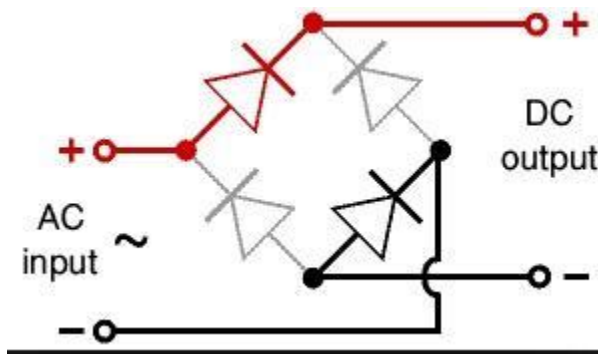
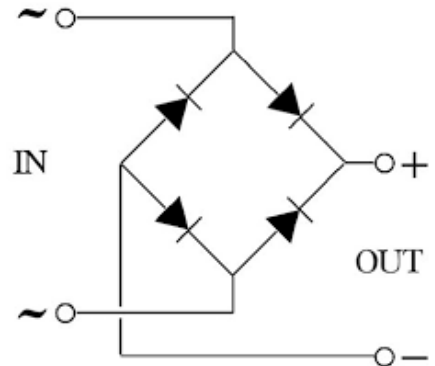

Schottky diode

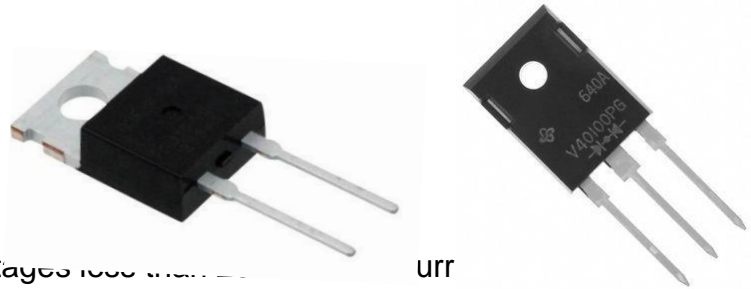

Function: Schottky diode works at voltages less than 100V and currents up to 100 amperes. So, it is suitable for the high current low voltage applications.

Test method: Schottky diode measuring and testing depends on the general diode characteristics. It contains two diodes that unite at both ends of the anode and it is in the middle and the other two ends are the cathode and they are also united. There is one type of Schottky diode that has only two ends and is treated as a general diode when measuring and testing.

Characteristics: One of the most important features of the Schottky diode is that it is fast opening and closing so it is used in high-frequency circuits. Due to the speed of the Schottky diode, it is used in high-frequency applications including the microwave band because it has a small saturation capacity. So, it is used to reduce the voltage in induction. It is also used as an AC rectifier, and it can work up to frequencies higher than 1 MHz.

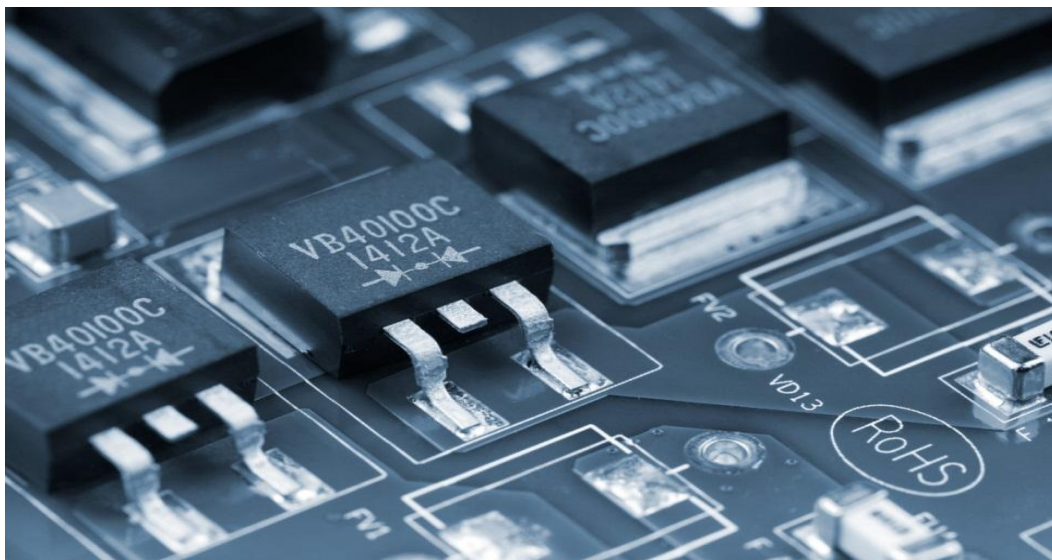

Zener Diode



Function: Zener Diode cuts off excess voltage (specified by the manufacturer) and is usually used to stabilize the voltage at a particular point in the circuit at a certain value which is written on the Zener diode.

Unit of measurement: Measured by Zener volt (V_z).

Features: Not all glass modules are Zener modules, some are standard glass modules. I advise using the websites to find out the type of module and its Zener voltage according to the number printed on it.

Test method:

- The first way: On the test board, connect the circuit as shown in the figure and change the voltage from Zero to a higher value (e.g. 24V) If the Zener is working well, the voltage will rise from zero until the It reaches the Zener voltage (e.g. 9v) and remains constant.
- The second way: Use a digital multimeter, set the indicator to measure the diode and you will find the right button measure only in one direction (such as the

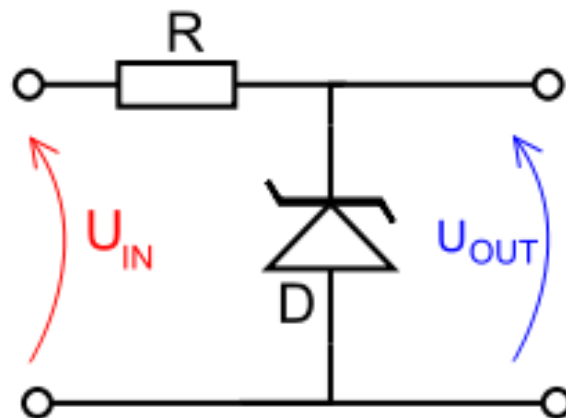

general diode) or you will find that one direction has a much higher resistance, for example, 10Ω and $100K\Omega$.

Varactor Diode, Tunnel Diode

Function: Variable capacitance diode acts as a capacitor in reverse bias, except that its capacity varies according to the bias voltage. The condenser valve consists of a valve



and a condenser that changes in terms of current passing through the poles. Condenser valves are used for voltage control and are often found in amplifiers, parametric oscillators and frequency analyzers, which are rare.

For example, condenser valves are used in the manufacture of televisions to determine the frequencies transmitted.



Function: The tunnel diode operates at very high speeds and its operation is very different from the normal diode. This type is used in frequency converters and detectors. Because of its structure, it is also used as oscillators, amplifiers and switching circuits which is rare to use.

BJT

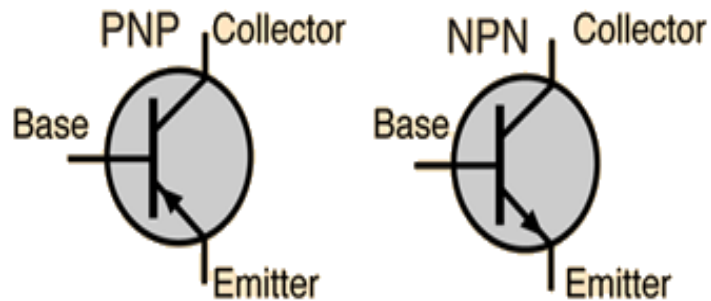

Transistor is the most important invention of the last century, its invention led to the advancement of electronics in a large and amazing way.

Function: The transistor amplifies, connects and disconnects electrical signals (acts as an electronic switch).

The terminals of the BJT bipolar transistor are:

B: Base

C: Collector

E: Emitter

Features: In the bipolar transistor, the conductivity between the C and E terminals depends on the current passes through B. If the current passing in B is zero, the resistance of the transistor is very high between C and E. When the I_B current reaches a certain value, the resistance of the transistor becomes very small.

The BJT transistor resistance changes linearly, so it is suitable for enlarging analog signals.

The transistor works at one of three operating situations:

The cut-off region in which the resistance between C and E is very high (as if it is an open switch).

The saturation region where the resistance between C and E is very low (as if the switch is closed ON)

The active region in which the resistance between C and E is an average value.

Disadvantages: One of the drawbacks of BJT is that it does not withstand high voltages or high temperatures. It also consumes a higher amount of energy than other types of transistors.

Test method: The transistor is a complex element because it has many different types in different specifications such as internal resistance, magnification, current and power tolerance.

Therefore, we recommend the use of advanced devices to analyze and test different types of transistors. Transistors can be tested by a multimeter, which is a fairly easy way and can be relied upon if we supposed that the transistor is bipolar junction consists of 2 diodes as in figure.

Important note: The resistance between B and E is slightly larger than the resistance between B and C.

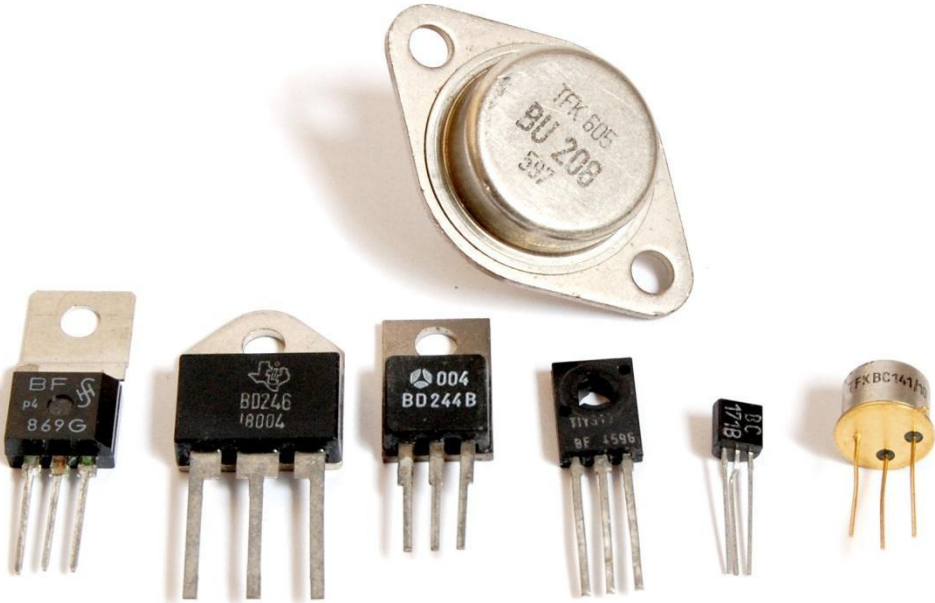
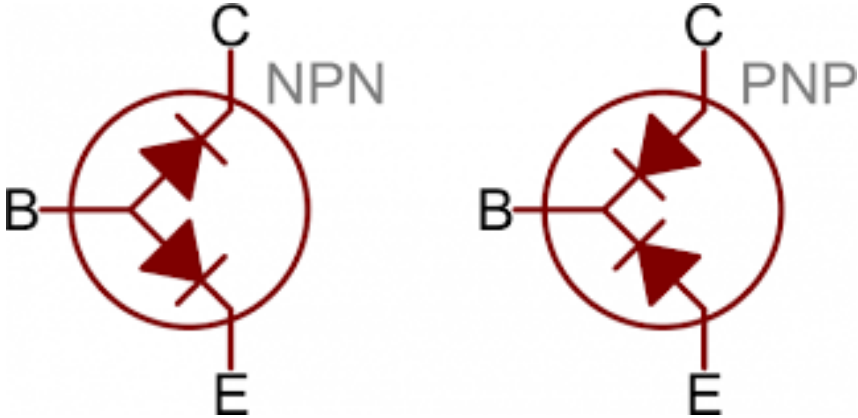

FET

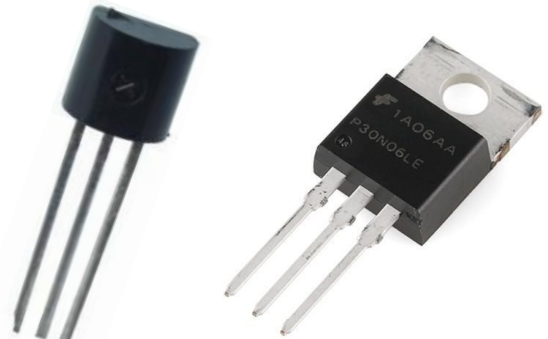
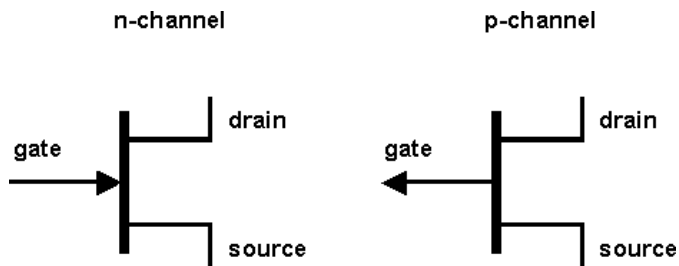

© 2000 B. M. Tissue

Function: The FET transistor works like a normal transistor (BJT) except that its conductivity depends on the voltage value at the G (end) and not on the base current as in the BJT transistor. The FET transistor species are various and widely studied. We can't study all of them.

The terminals of the FET transistor are:

- G: Gate
- D: Drain
- S: Source

Features:

- 1- Easily manufactured in integrated circuits.
- 2- Input resistance is very high, therefore consumes less power and emits less heat.
- 3- Withstands higher temperatures than BJT.
- 4- It can work with digital signals faster than the BJT and emits less noise.

Disadvantages: it does not enlarge linearly (in other words it is not suitable for analog signal amplification).

UJT

Function: it is like the JFET transistor except it differs in size and the manufacturing

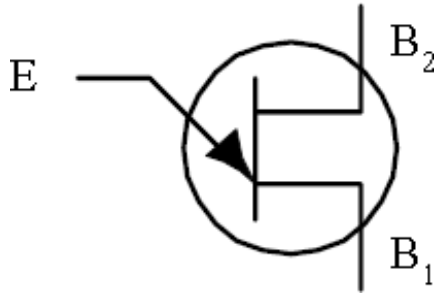

material. It is easy to manufacture oscillators' circuits using this type of transistor.

Features: it cannot amplify an analog signal because it is not constant.

It is suitable to generate pulses with low or medium frequencies.

The UJT transistor is rarely used nowadays. It has been developed to a TUP or Programmable UJT.



© Premier Farnell
Copying of image is prohibited.

SCR

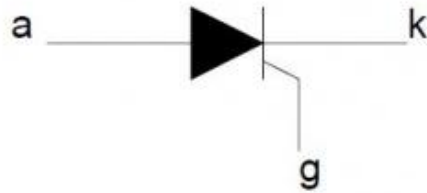
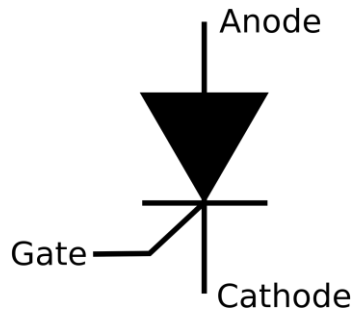

Function: it works similarly to a normal diode, it connects only in forward bias, and only if positive pulse at the end of the G is applied.

Features: When the thyristor is connected, it maintains the connection status. It does not return to the cutting state Unless the anode-cathode current is interrupted, or a negative voltage is applied to the anode (for the cathode).

The figure explains an application for thyristor work.

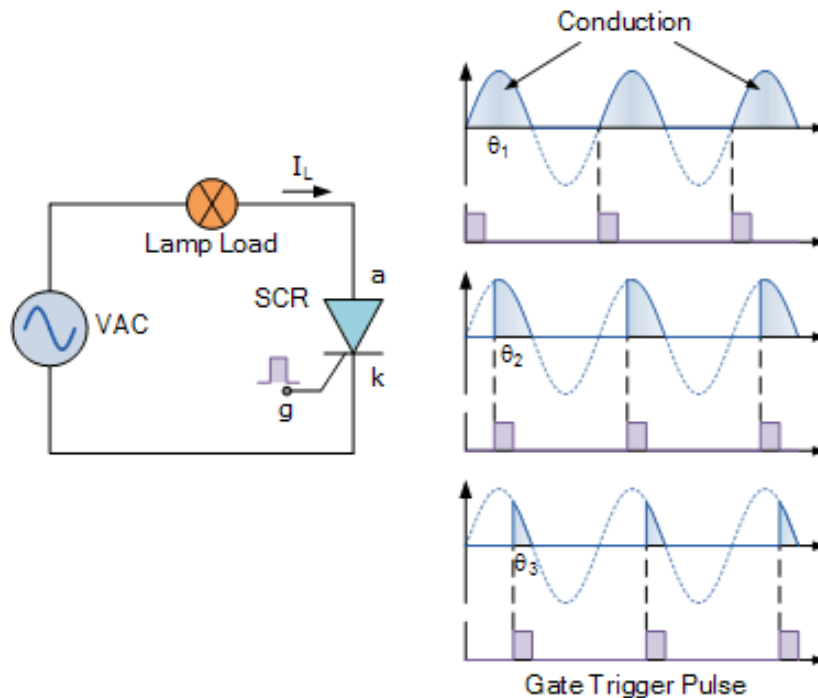

Test Method: It is advisable to use the advanced semiconductor analyzer to easily test the thyristor. It will determine the location of the terminals and other thyristor features.
Another way to test the thyristor: set the multimeter on the test mode of the diode, put



the red wire on the anode and the black on the cathode. Put the multimeter on the test mode of the diode, put the red wire on the anode and the black on the cathode. Here the resistance must be very high, then connect another wire and make it connect the red wire to the G terminal and connect it for a short time, here the resistance of the thyristor must be transformed into a very small resistance. It stays until you retest. In the case of a re-experiment with the polarity (red on the cathode), the resistance should never be less

Illustrative circuit for thyristor use.

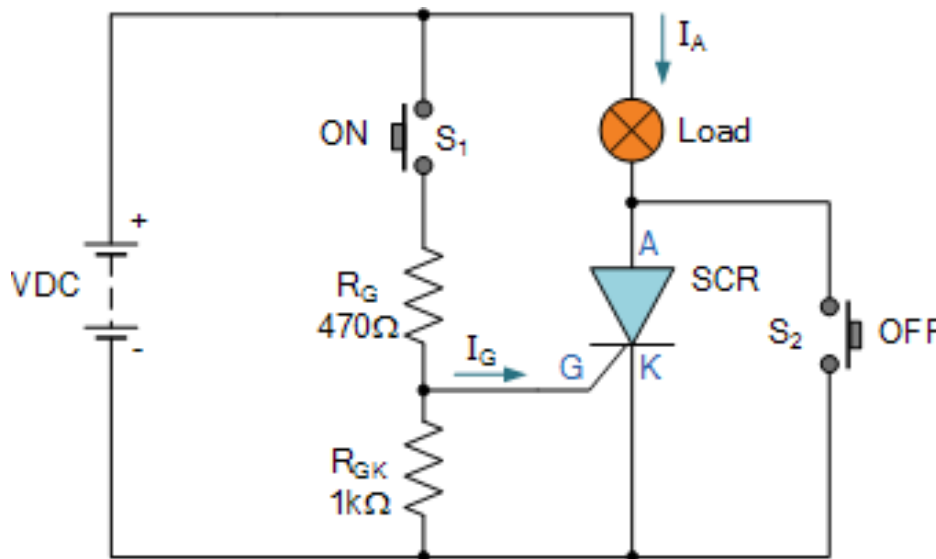

Diac

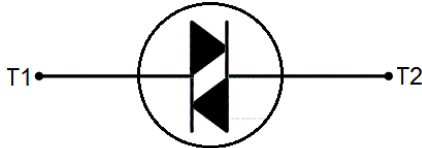
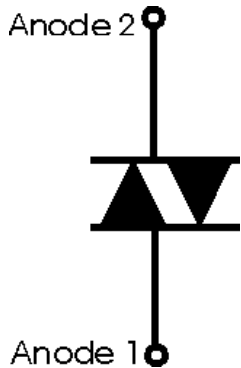

© www.petervis.com



theE.net

Function: Diac allows the current to pass in both directions only if the voltage difference between its terminals exceeds the Back over-voltage VBO instantly, then it keeps its connection state even if its voltage drops again.

Unit of measurement: VBO is between 7Volts to 140Volts.

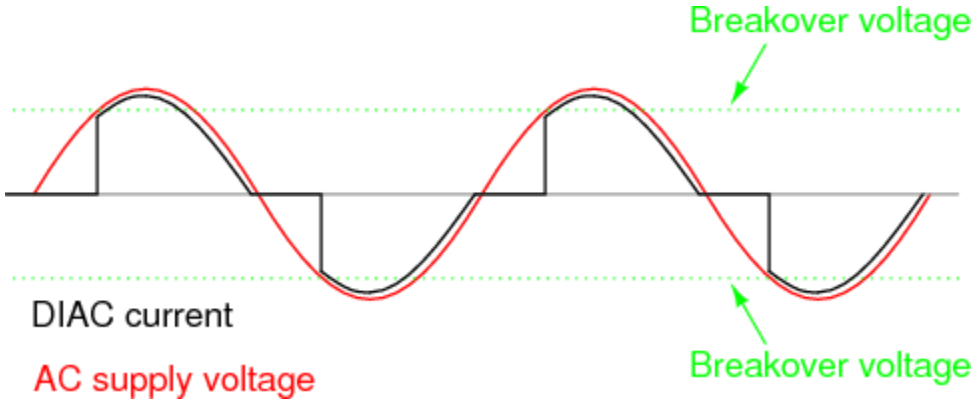

Test Method: we have to use an AC voltage source that can be controlled, a bulb (example), and a suitable resistor. Increase the voltage until it exceeds the VBO. The bulb then has to light and stays even if the voltage decreased over the VBO.

Triac



Function: Triac works as thyristor but it allows the current to flow in both directions.
Unit of measurement: Volt

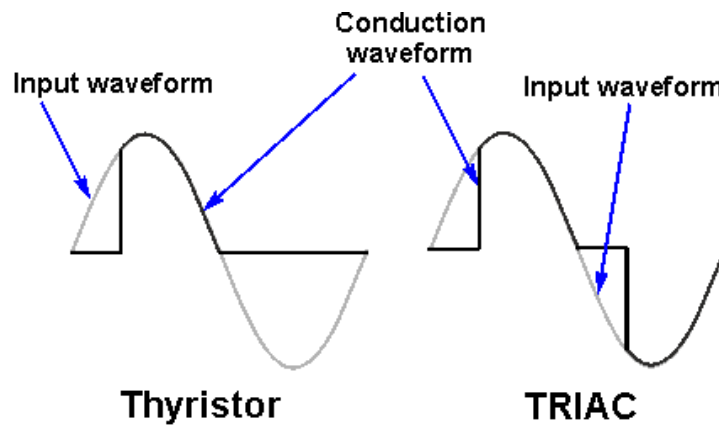

Test Method: put the DMM on the diode testing option. Connect the red terminal with 1T, and the black terminal with 2T.
 A very high resistance will be measured. Put your hand as a connector between the red terminal and the G terminal.
 The Triac resistance will decrease and when you remove your hand. Its resistance must stay small.
 Repeat the previous steps with reversing the terminals, you will find the same results.

Optoelectronic devices

Optoelectronic devices are electronic components that convert energy to light or vice versa and can be used elements photolithography different formats (such as traffic signal) (certain signals) (display unit numbers)

LED Light Emitting Diode

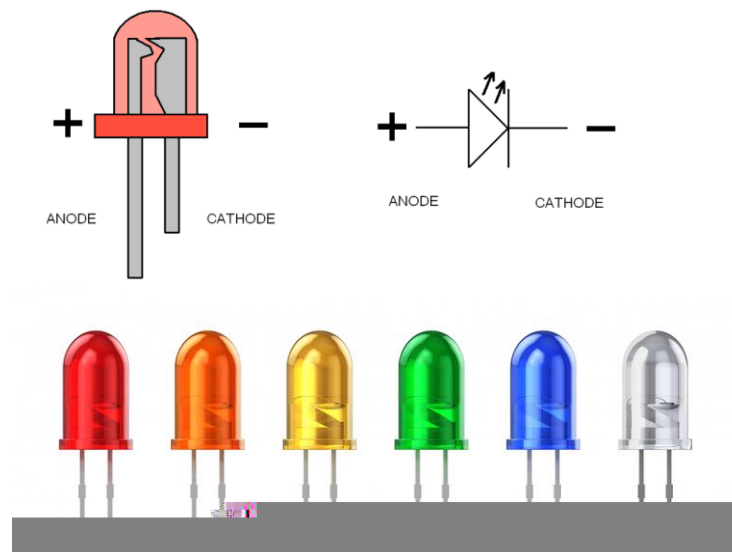

Work :What distinguish LED from other diodes Is the release of the light when the current passes through it, this happens when the diode is in the forward bias.

Characteristics :LEDs vary in size, shape, capacity and operating voltage, if you want to operate them with a higher voltage than the operating voltage, then you need to know the value of the appropriate resistance that must be connected with the LED to protect it from over-voltage.

Using LEDs, a lot of configurations has been made in many applications such as- :

-Seven segment Displays

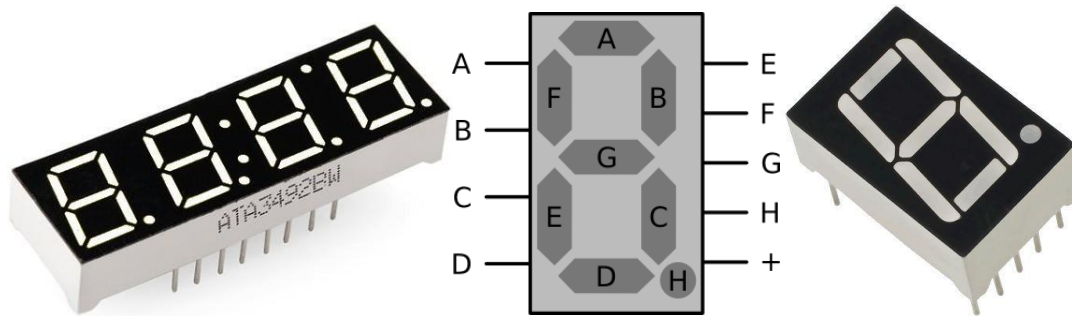

Simple LCD display



LDR Light Dependent Resistor

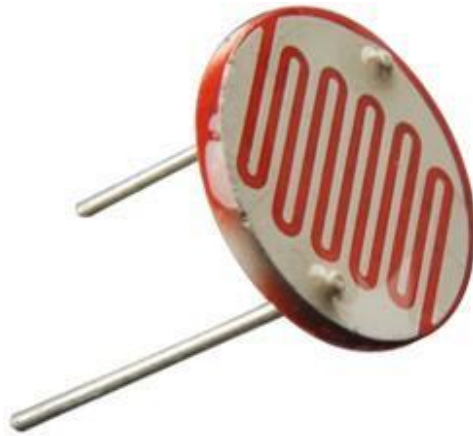

work :It is a type of resistance that change their value (Ohm) depending on light intensity. the higher the light, The lower the resistance,

Unit of measurement :The photoresist is measured in ohms but has no fixed value due to its dependence on light.

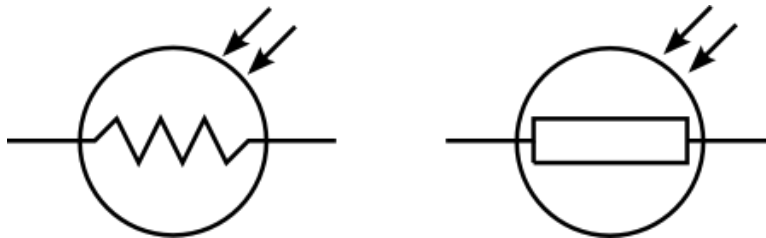

Properties : There are different sizes of photoresist suitable for different applications and in some cases used as a light-based electronic switch to operate a circuit as shown in Figure

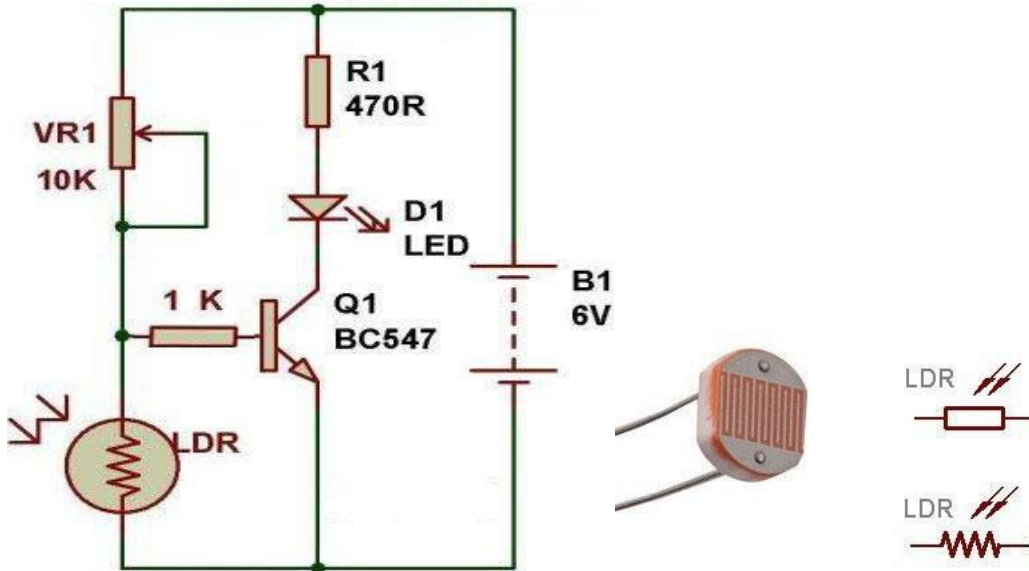

Test : Try to measure the resistance of the photoresist

when the resistance is in a high-light position and then cover it (the value of the resistance in the shade must increase)



Photodiode

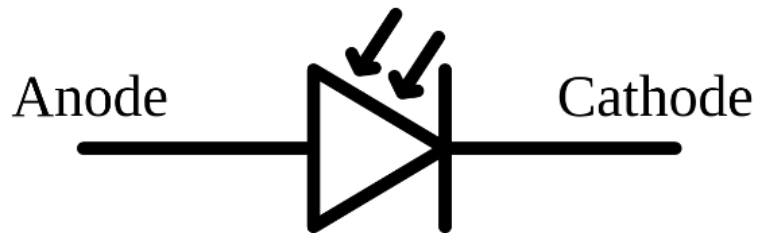

Work: it allows current to pass in the opposite direction only when it's directed to its light-sensitive area .

Test :Place the multimeter on the diode test mode and connect the photodiode in the opposite direction (Red prop on cathode) it must allow current to pass when there is light on the lens otherwise it shouldn't allow current to pass.



Solar Cell

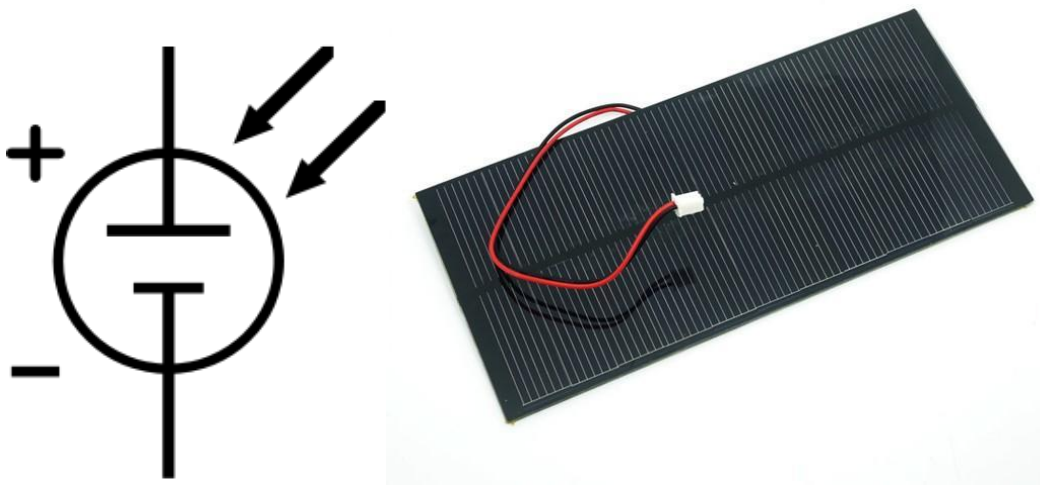

Work : The solar cell generates a continuous DC (voltage, current, and power) when directed toward sunlight (it uses Sunlight)

Measurement unit : Volt and its power is usually measured in watt

Characteristics : The solar cell is a low-efficiency element in energy conversion .The solar cell's efficiency doesn't exceed 25% while the highest efficiency ever achieved in a solar cell is 45%.

Test Method : Place the solar cell under bright light and measure its voltage by using a multimeter.

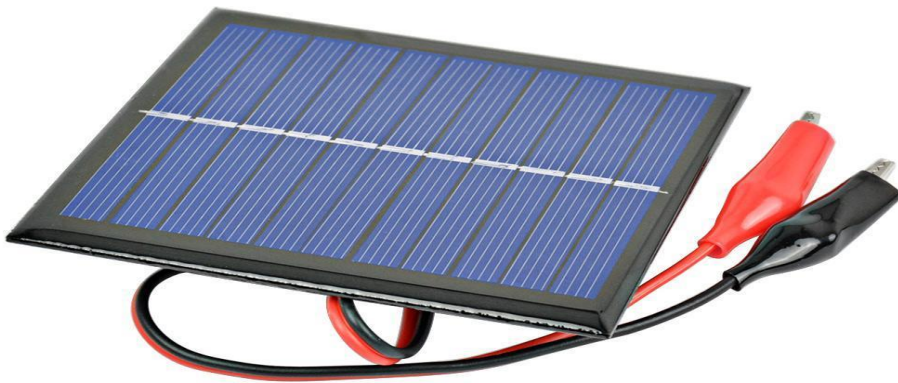
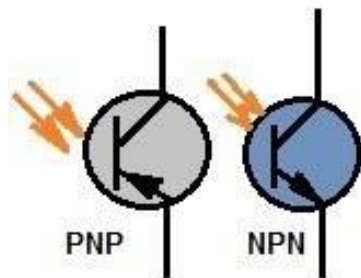

Photo Transistor



Work: The optical transistor changes its internal resistance (between the Collector and Emitter ends) depending on the intensity of the light directed at the lens or the voltage applied to the Base.

Unit of measurement :None, but each transistor has its own characteristic curve.

Characteristics : there are two types of Optical transistors: PNP - NPN. Some optical transistors have 3 legs, and some have only two, these usually doesn't have a base terminal



Test method :

NPN

- We put the multimeter at resistance measurement
- Red prop on Collector
- Black on Emitter
- The resistance must decrease as the light intensity increases on the lens.

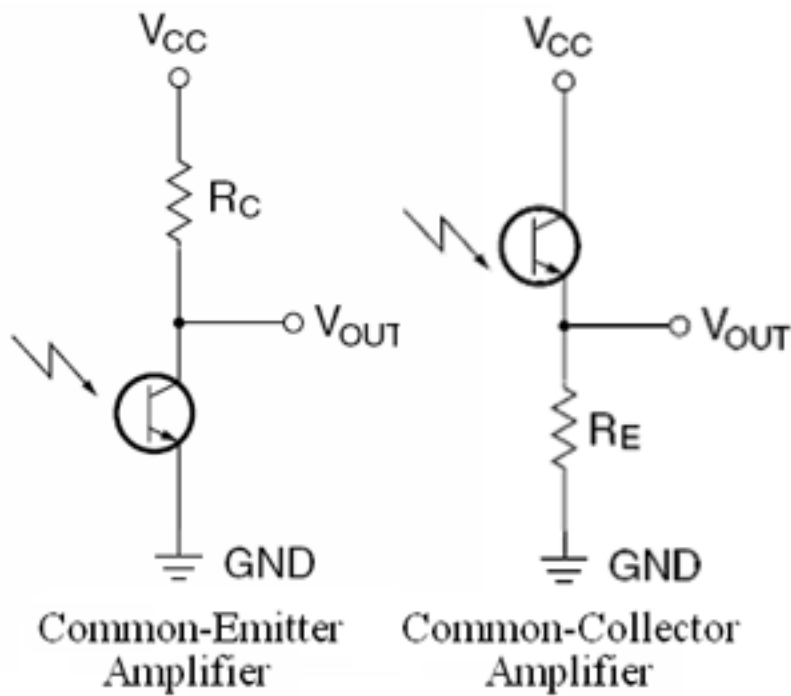

Optocoupler Opto-isolator

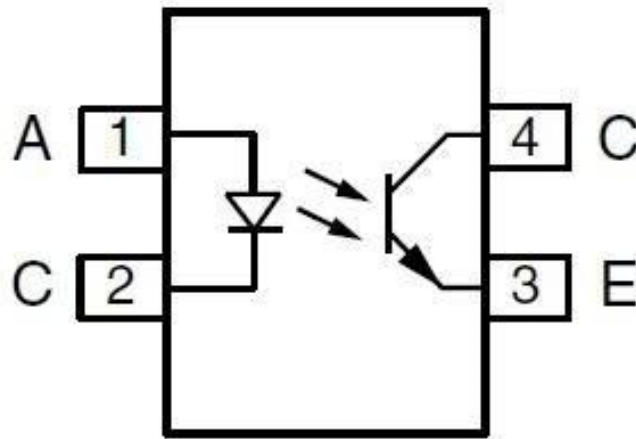

Working Principle : The optical isolation circuit is used to connect two electronic circuits allowing the electrical signal to be transferred safely from the control circuit to the operating circuit. The benefit of using an optocoupler is to protect the control circuit from any problems that may occur in the operating circuit.

Unit of measurement : There is no specific unit of measurement, but they are usually identified by the number of channels (signals) that can be connected and isolated.

Characteristics : There are different sizes of photovoltaic strips. Some have 4 terminals, some 6 and some have a large array of inputs and outputs to isolate several signals in a single chip.

Test Method :Check the isolation circuit datasheet. Then apply input signal on the Photodiode and monitor the resistance change between the two output terminals (E, C) of the transistor, the output resistance should be reduced when input voltage is applied.

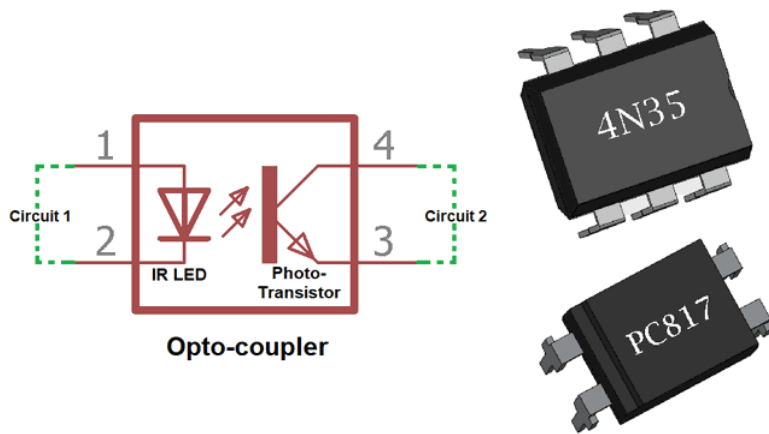
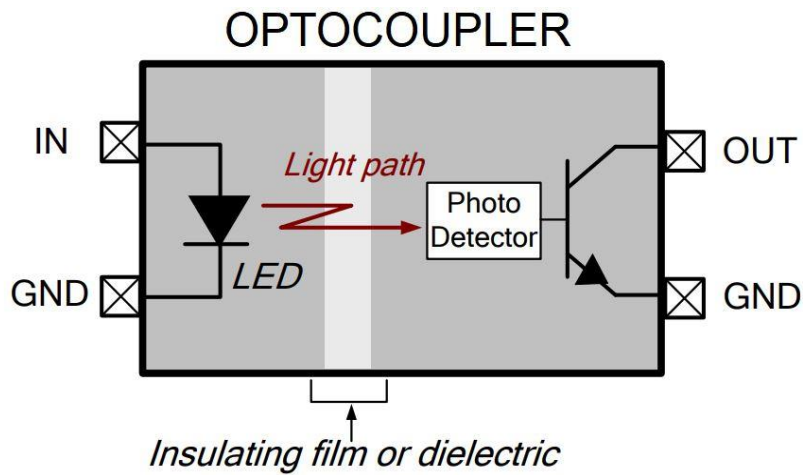

Voltage Regulators

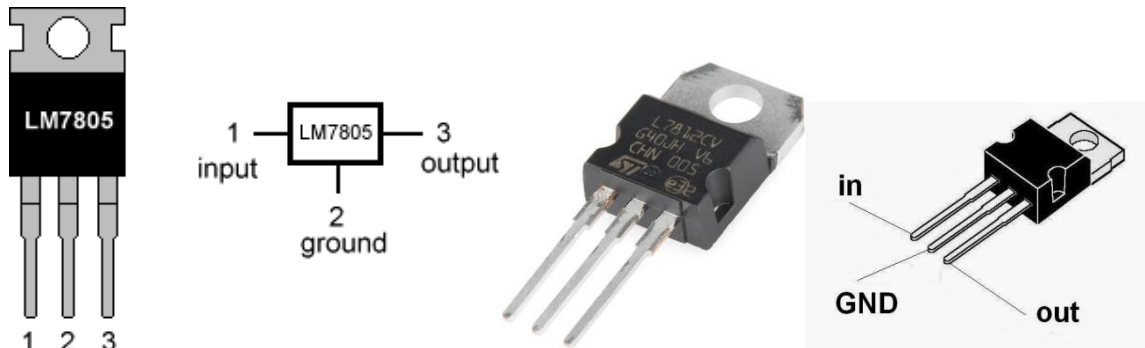

Action :Voltage-stabilizing integrated circuits (as shown in their name) stabilize the voltage at a given value and these circuits are way much better than Zener diodes in maintaining the voltage at a specified level.

Unit of measurement :output Voltage measured in Volt

Types :

- Maintain voltage at a constant positive value such as: 7805LM that maintain +5v.
- Maintain voltage at a constant negative value such as: 7905 that maintain -5v.
- Maintain voltage at a level determined by other circuit element connected to it, such as a potentiometer value such as: LM317.

Most voltage stabilizers are connected to capacitors as shown below to improve output stability.

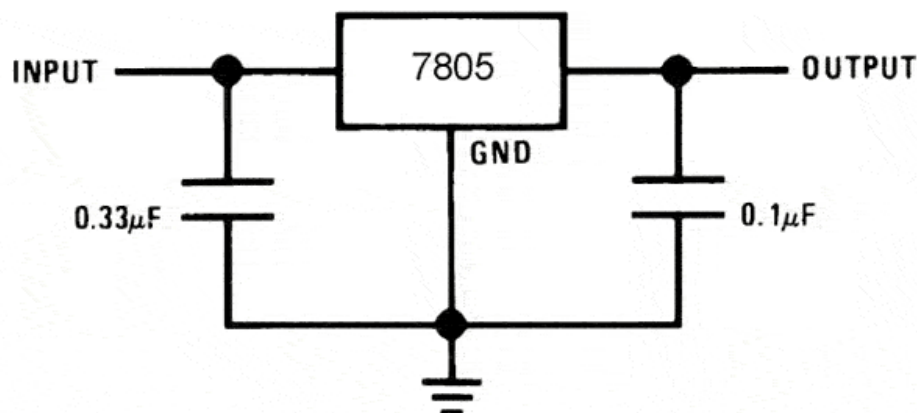

Properties :Voltage stabilizers usually overheat during operation, so they must be attached to the heat-dissipation metal/Aluminum piece.

Operational Amplifier

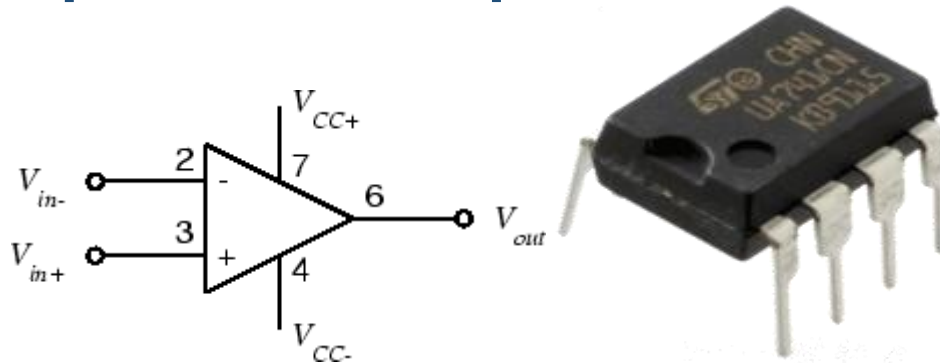

Work: The operational amplifier can be used to perform many tasks in electronic circuits, such as:

- inverting amplifier: Amplifying signal and reversing its polarity
- **Non-inverting Amplifier:** Amplifying signal without reversing polarity
- **Isolation Amplifier:** Connecting two circuits and isolating power transitions between them.
- **Summing Amplifier:** Summing multiple voltage input and output them on one terminal
- **Oscillator:** oscillator circuit to generate a sinusoidal signal
- **Comparing Amplifier:** compare two voltage values
- **Filter Circuits :** To filter or block some frequencies
- **Derivative Circuits :** output an analog signal expressing the differential of the input signals
- **Integral Circuits :** output an analog signal expressing the integration of the input signals

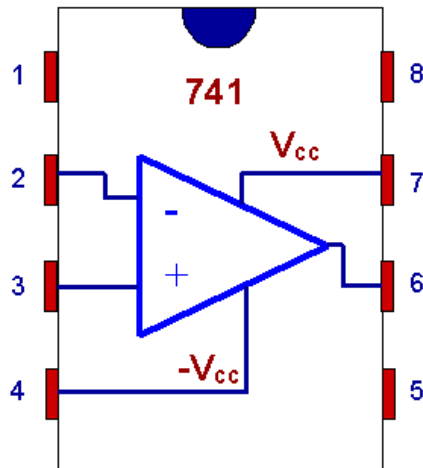

Connecting Inverting and Non-Inverting Amplifier

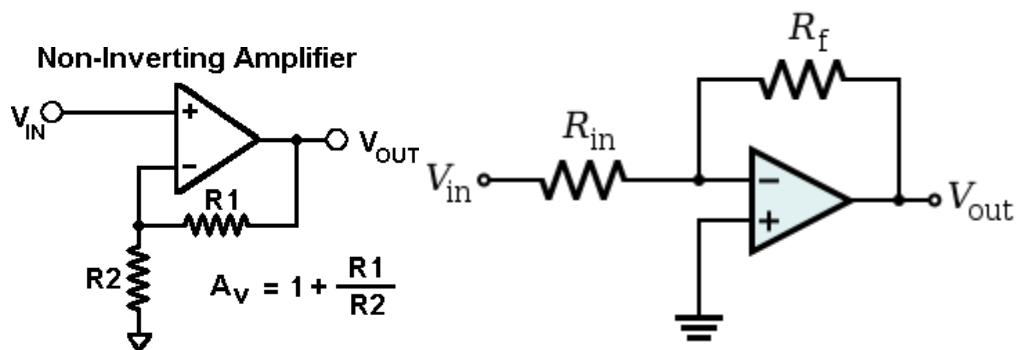

Types: The operational amplifier is available in different segments with different connections and shapes, the most famous is the 741 chips . 8-pin IC that has one operational amplifier. Some types have two or more amplifiers in the same chip.

FEATURES: For the amplifier to function properly, the feeding pins on both ends of $V +$ and $-V$ must be connected to the voltage required by the amplifier design.

Timer 555

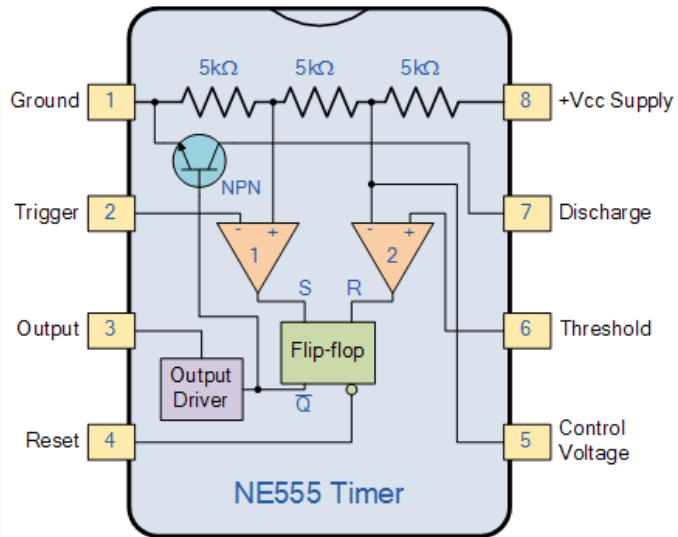
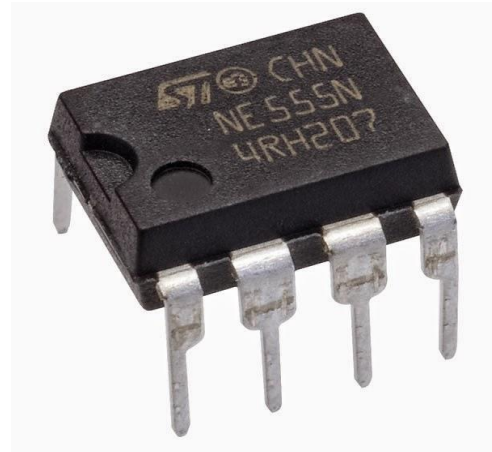

Timer 555 is an integrated circuit that can be used in many digital applications. It has two main uses.

- **Non-stable Circuit:** The timer generates pulses (square) at a frequency determined by the elements connected with it. These pulses are used to adjust synchronization in digital circuits.
- **Monostable Circuit:** The timer adjusts the width of pulses.

Test Method: It is advisable to connect the timer in an oscillator circuit to test its output terminals.

Conclusion

Electronics is a renewed and accelerated beautiful science, an applied science in which ideas turn into reality.

Knowing electronic elements and their work is an important step in the field.

Electronics are divided into many specializations such as analog circuits, digital circuits, control, communications, sensors industry, integrated circuits, small computer systems, and with the great development of science, electronics can be used in every home. Starting with the simplest things that everyone uses to the end of the most complex, such as television, radio, digital cameras, cars, aircraft, medical devices, computers and many other devices that cannot be counted.